

1
Unpack the Shimmerclick boards.
If attaching to a wall, clean the surface.

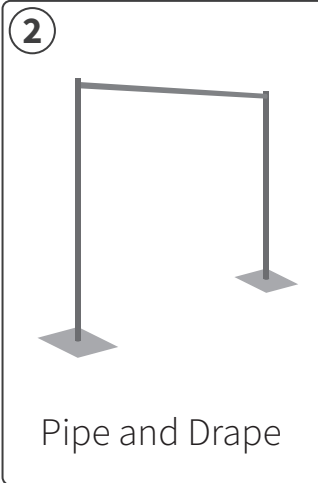

Pipe and Drape

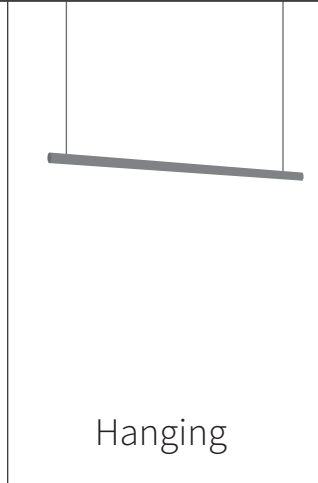

Hanging

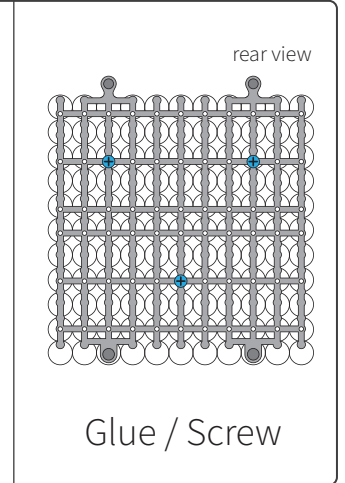

Glue / Screw

If installing by Pipe and Drape or Hanging, attach the top row of boards to the bar with cable ties. If installing on a wall, attach the top row of boards using 3 screws or transparent silicon glue.

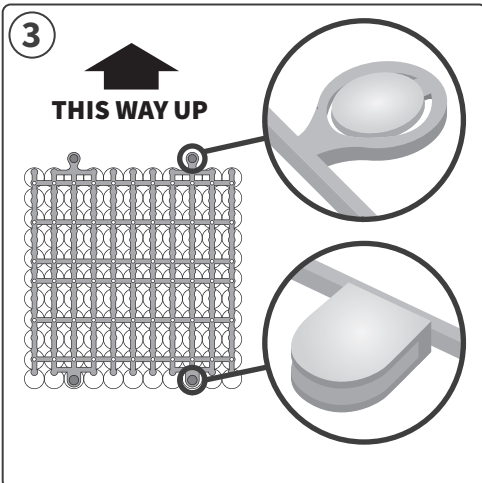

3
Ensure the boards are correctly oriented.
The connectors should be pointing up,
and the sockets should point down.

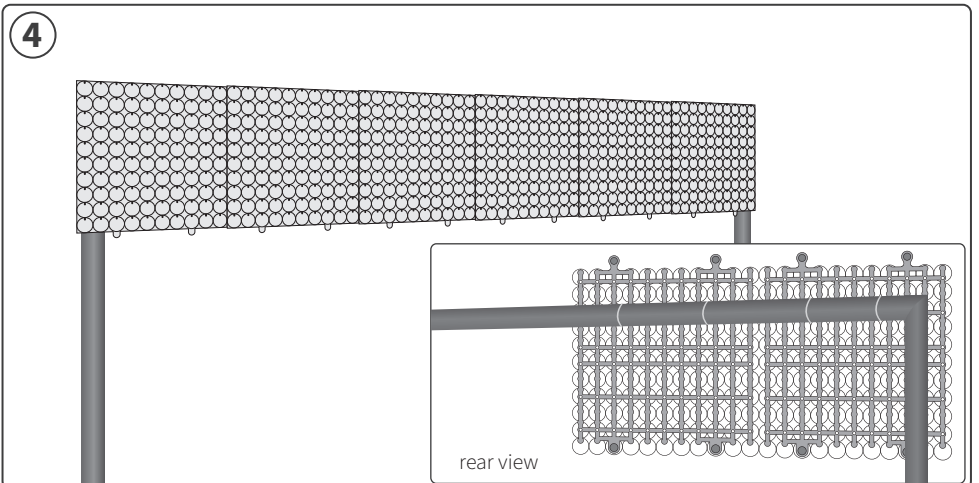

4
Attach the top row of boards first. These should attach midway up the top row in order
to hide the pole.

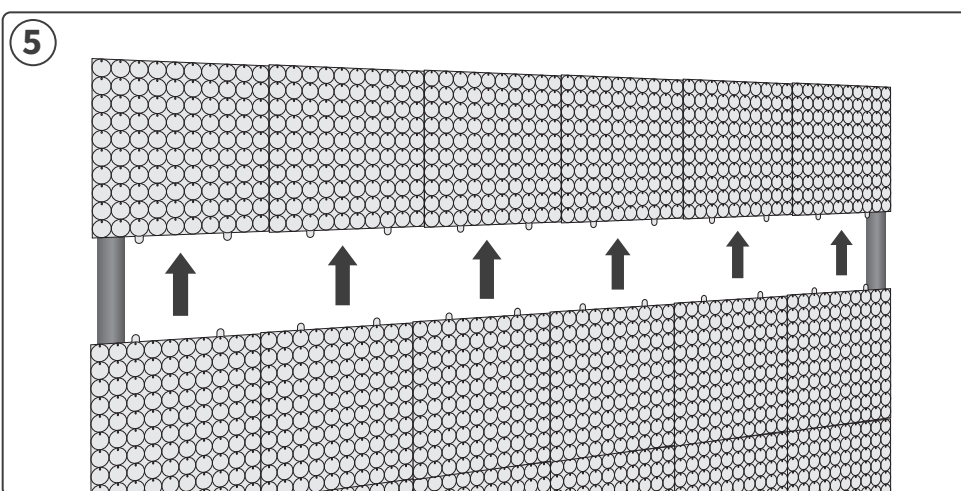

5
Finally, clip the rest of the Shimmer Click boards on, column by column!

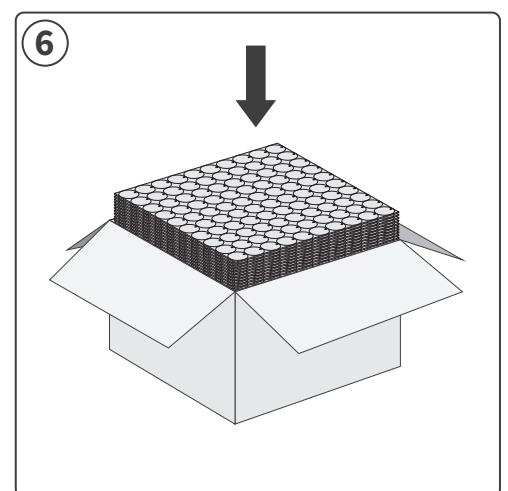

6
The boards can be stacked and packed
back into the box for reuse.

*For circles and rectangles, the installation method is the same.

1. Each board is labelled with a Letter (Row) and Number (Column).

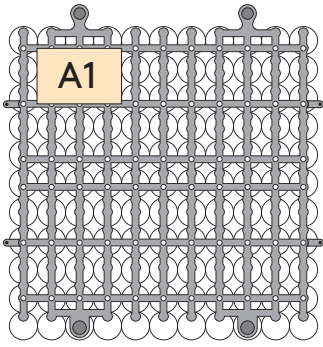

2. After removing the Shimmerclick boards from the box, connect each board using the side connectors firstly by row A.

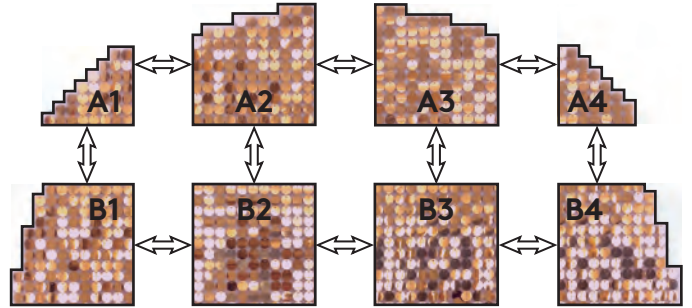

3. Lastly, attach the rows starting with A, then B, then C, etc. using the Click Connectors.

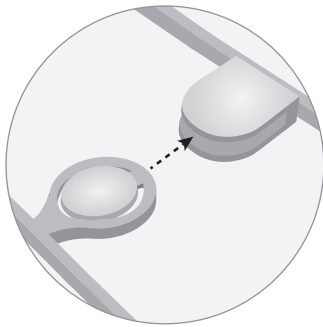

Top & Bottom Sides

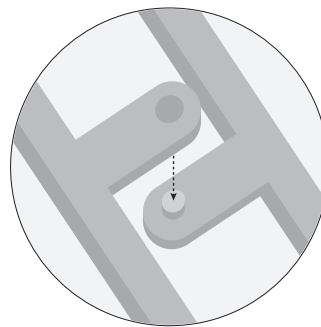

Left & Right Sides

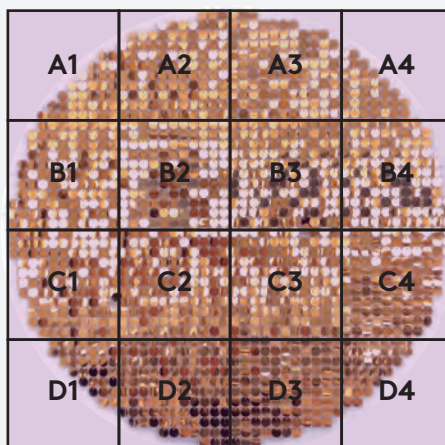
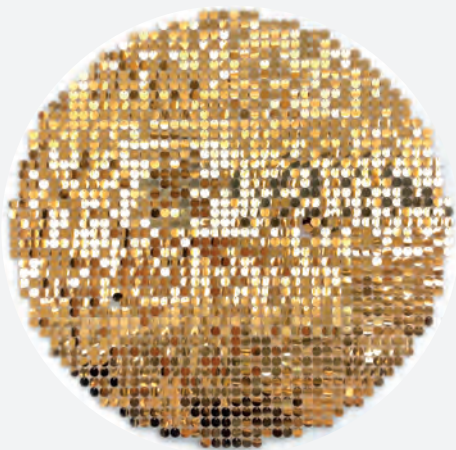

Set-Up Video
Tutorials

Shimmerclick panels can be cut to specified shapes easily and quickly.

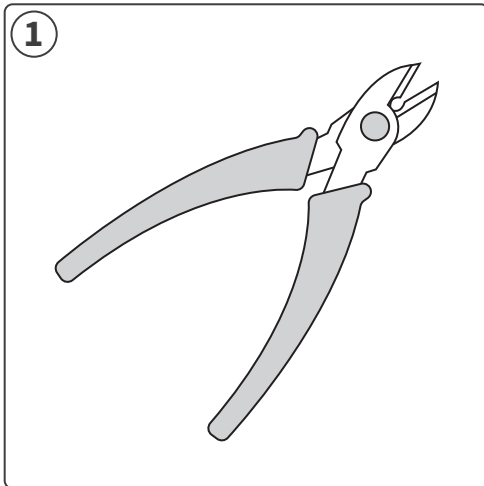

The most effective tool to use is a pair of cutting pliers.

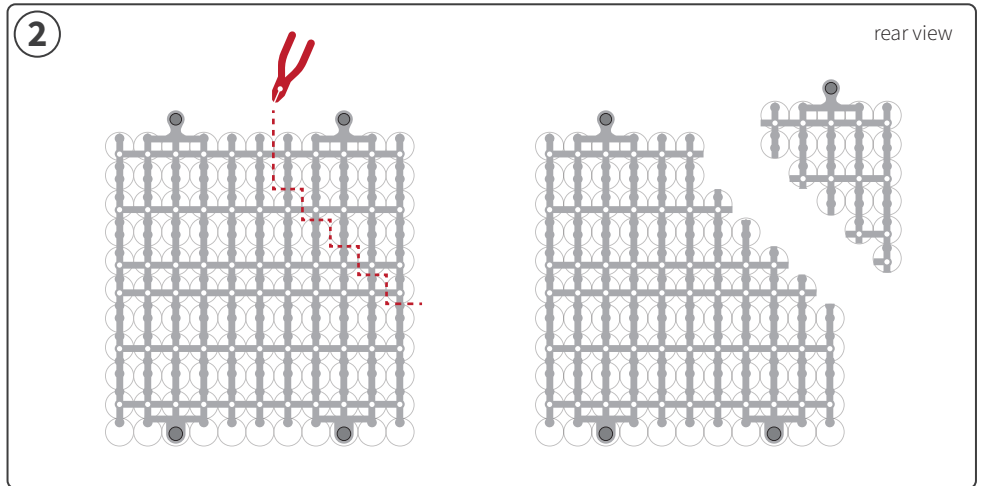

Use the cutting pliers to snip off unwanted parts of the panel.

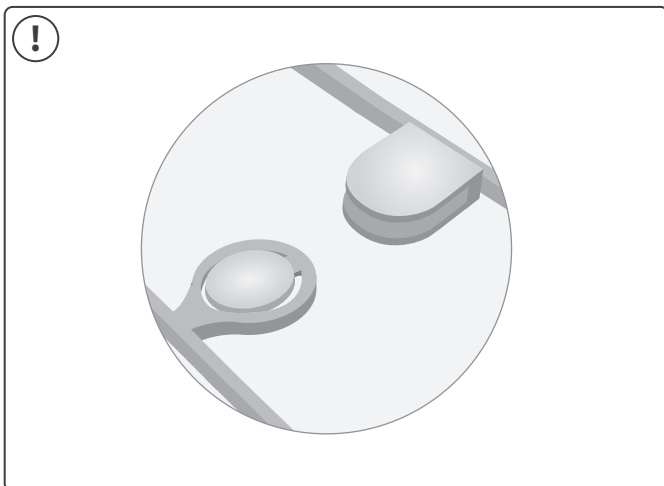

Be careful not to cut off more connection points than necessary, or the panels will not connect effectively.

If your Shimmerwall is going to be hung, aim to keep at least one connection point on each edge of the panels.

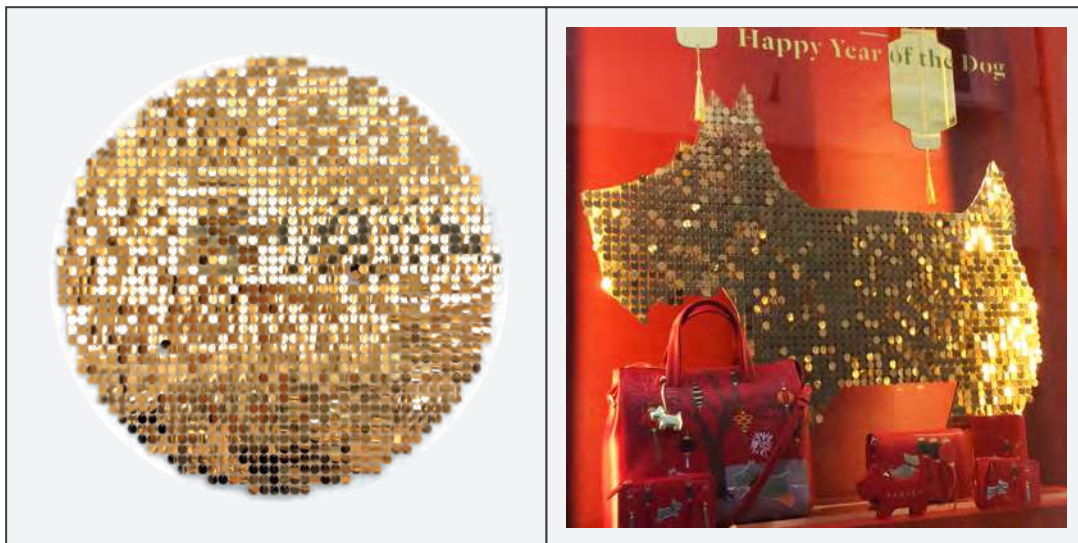

Final Product